



Distributed by:

Lab Unlimited
CARL STUART GROUP

Tallaght Business Park
Whitestown, Dublin 24,
Ireland
D24 RFK3

Tel: (01) 4523432
Fax: (01) 4523967
E-mail: info@labunlimited.com
Web: www.labunlimited.com

Quatro House, Frimley Road,
Camberley,
United Kingdom
GU16 7ER

Tel: 08452 30 40 30
Fax: 08452 30 50 30
E-mail: info@labunlimited.co.uk
Web: www.labunlimited.co.uk

TC-Series Circulating Baths with Standard Digital Temperature Controller

Operator's Manual



Models:

TC-150SD
TC-250SD
TC-550SD
TC-650SD
TC-950SD



Table of Contents

Introduction	3
Brookfield Circulating Baths with Standard Digital Temperature Controller	3
Performance Specifications	4
General Safety Information	5
Safety Recommendations	6
Regulatory Compliance and Testing	7
Unpacking Your Circulator	7
Contents	8
Controls and Components	9
Quick-Start	12
Installation and Startup	14
General Site Requirements	14
Adding Liquid to the Bath Reservoir	14
Pump Inlet and Outlet Connections	15
External Closed Loop Circulation	15
Refrigeration Control Connections (Refrigerating/Heating Circulators only)	16
Electrical Power	16
RS232 Serial Communication	17
Controller Setup	18
Normal Operation	20
Keys and Controls	20
Turning Your Circulator ON	20
Main Operational Display (Home)	21
Set-Up Sub-Menus	21
Adjusting the Temperature Set Point	22
Selecting the Temperature Unit	23
Selecting the Pump Speed	24
Calibrating Your Circulator	25
Setting the Low Limit Temperature	26
Setting the High Limit Temperature	27
Selecting the Serial Communication Baud Rate	28
Setting the Auto Cool Temperature	29
Resetting the Factory Default Values	29
Changing Your Circulator's Viewing Angle	30
Loss of Power Restart	30
Inert Gas Purge	30
Display Messages and Alarms	31
Routine Maintenance and Troubleshooting	32
Maintaining Clear Bath Water	32
Draining the Bath Reservoir	32
Checking the Over-Temperature Safety System	33
Cleaning Your Circulator	34
Temperature Controller	34
Bath Reservoir	34
Pump Impeller	34
Condenser, Air Vents, and Reusable Filter (Refrigerating / Heating Circulators only)	34
Temperature Controller Removal and Re-Installation	35
Removal	35
Re-Installation	36
Troubleshooting Chart	37
Technical Information	39

Reservoir Fluids	39
Application Notes	40
RS232 Communications	41
Using Bath Controller with Rheocalc Software	41
Using Bath Controller with DV-III+ or DV-III Ultra Rheometer in Standalone Mode	41
RS232 — For use without Brookfield Software (for customers using their own software)	42
Equipment Disposal (WEEE Directive)	44
Replacement Parts, Optional Accessories & Fluids	45
Warranty Repair and Service	46

Introduction

Thank you for choosing a Brookfield Circulating Bath with Standard Digital Temperature Controller. Extremely easy to use and maintain, it combines design innovation with highly intuitive operation to deliver convenient and reliable liquid temperature control for a wide range of applications.



WARNING: Brookfield Circulating Baths are not intended for directly controlling the temperature of foods, pharmaceuticals, medicines, or other objects which may be ingested by or injected in humans or animals. Any such objects must be isolated from contact with the bath fluid and bath surfaces.

Here are some of the features that make your Circulating Bath so user-friendly:

- Simple, intuitive operation
- Extra-large digital readout that displays actual and set point temperature simultaneously
- Powerful two-speed pressure pump with external circulation capability for closed-loop applications
- 180° viewing radius (Swivel 180™ rotating control head)
- DuraTop™ heat and chemical resistant top plate
- Built-in temperature protection
- Suitable for use with Class I non-flammable fluids per DIN 12876-1

It will take you very little time to get your new Circulating Bath installed and running. This Operator's Manual is designed to guide you quickly through the process. We recommend that you read it thoroughly before you begin.

Brookfield Circulating Baths with Standard Digital Temperature Controller

Model Type	Reservoir Capacity	Temperature Range	
		°C	°F
TC-150SD Heat only Circulator *	6 liters	Ambient +10°C to 150°C**	Ambient +20° to 302°F**
TC-250SD Heat only Circulator *	10 liters	Ambient +10°C to 150°C**	Ambient +20° to 302°F**
TC-550SD Refrigerating/Heating Circulator	7 liters	-20° to 170°C	-4° to 338°F
TC-650SD Refrigerating/Heating Circulator	7 liters	-20° to 170°C	-4° to 338°F
TC-950SD Refrigerating/Heating Circulator	15 liters	-30° to 170°C	-22° to 338°F

*. Compatible with optional TC-351 Chiller for low temperature operation to -15°C (5°F).

**.. Upper temperature limit based on reservoir construction. Temperature controller capable of higher temperatures.

Performance Specifications

Operating Temperature Range:	Model dependent; see table below	
Temperature Stability:	±0.04C (±0.08°F)	
Pump Type:	2-speed pressure	
	<u>60Hz models</u>	<u>50Hz models</u>
Maximum Pressure:	3.5 psi (0.24 bar)	2.9 psi (0.20 bar)
Maximum Pressure Flow Rate:	2.9 gpm (11.0 lpm)	2.7 gpm (10.2 lpm)
Heater Wattage:	1100 watts	2200 watts

Model Type	Reservoir Capacity	Temperature Range	Electrical Requirements		
			120V Units	240V Units	100V Units
TC-150SD Heated Circulator	6 liters	Ambient +10° to 150°C Ambient +20° to 302°F*	120V, 60Hz, 10A	240V, 50Hz, 10A	100V, 60Hz, 10A
TC-250SD Heated Circulator	10 liters	Ambient +10° to 150°C Ambient +20° to 302°F*	120V, 60Hz, 10A	240V, 50Hz, 10A	100V, 60Hz, 10A
TC-550SD Refrigerating/Heating Circulator	7 liters	-20° to 170°C -4° to 338°F	120V, 60Hz, 12A	240V, 50Hz, 12A	100V, 60Hz, 12A
TC-650SD Refrigerating/Heating Circulator	7 liters	-20° to 170°C -4° to 338°F	120V, 60Hz, 12A	240V, 50Hz, 12A	100V, 60Hz, 12A
TC-950SD Refrigerating/Heating Circulator	15 liters	-30° to 170°C -20° to 338°F	120V, 60Hz, 13A	240V, 50Hz, 13A	N/A









*. Upper temperature limit based on reservoir construction. Temperature controller capable of higher temperatures.

Environmental Conditions	Indoor use only
	Maximum Altitude: 2000 meter
	Operating Ambient: 5° to 35°C (41° to 95°F)
	Relative Humidity: 80%, non-condensing
	Installation Category: II
	Pollution Degree: 2
	Ingress Protection: IP 31
	Climate Class: SN
	Software Class: B
	Output Waveform: Sinusoidal

Specifications subject to change without notice.

General Safety Information





When installed, operated, and maintained according to the directions in this manual and common safety procedures, your Circulating Bath should provide safe and reliable temperature control. Please ensure that all individuals involved in the installation, operation, or maintenance of this Circulating Bath read this manual thoroughly prior to working with the unit.

	This symbol alerts you to a wide range of potential dangers.
	This symbol advises you of danger from electricity or electric shock.
	This symbol indicates that a hot surface may be present.
	This symbol marks information that is particularly important.
	This symbol indicates alternating current.
	These symbols on the Power Switch / Circuit Breaker indicate that they place the main power supply ON / OFF.
	This symbol on the Power Key indicates that it places the unit in a standby mode. It DOES NOT fully disconnect the unit from the power supply.
	This symbol indicates a protective conductor terminal.

**Read all instructions pertaining to safety, set-up, and operation.
Proper operation and maintenance is the user's responsibility.**

Safety Recommendations

To prevent injury to personnel and/or damage to property, always follow your workplace's safety procedures when operating this equipment. You should also comply with the following safety recommendations:

	<p>WARNING:</p> <ul style="list-style-type: none">• This Circulating Bath is suitable only for use with Class I non-flammable fluids (per DIN 12876-1).• Be aware of the chemical hazards that may be associated with the bath fluid used. Observe all safety warnings for the fluids used as well as those contained in the material safety data sheet.• Use only recommended bath fluids; see <i>Technical Information</i> in the rear of this manual for recommended fluids.• Use only non-acid bath fluids.
	<p>WARNING:</p> <ul style="list-style-type: none">• Always connect the power cord on this Circulator to a grounded (3-prong) power outlet. Make certain that the outlet is the same voltage and frequency as your unit.• Never operate the Circulator with a damaged power cord.• Always turn the Circulator OFF and disconnect mains power before performing any maintenance or service.
	<p>WARNING:</p> <ul style="list-style-type: none">• Never operate the Circulator without bath fluid in the reservoir. Periodically check the reservoir to ensure that the liquid depth is within acceptable levels. Always refill the reservoir using the same bath fluid that is already in the reservoir. Bath oil must not contain any water contaminants and should be preheated to the actual bath temperature before adding as there is an explosion hazard at high temperatures.• Always drain all fluid from the reservoir before moving or lifting your Circulator. Be sure to follow your organization's procedures and practices regarding the safe lifting and relocation of heavy objects.
	<p>WARNING:</p> <ul style="list-style-type: none">• Always allow the bath fluid to cool to ambient temperature before draining.• The reservoir cover, top deck, and/or external pump connections may become hot with continuous use. Exercise caution when touching these parts.
	<p>WARNING: It is the user's responsibility to properly decontaminate the unit in the event hazardous materials are spilled on exterior or interior surfaces. Consult manufacturer if there is any doubt regarding the compatibility of decontamination or cleaning agents.</p>

Regulatory Compliance and Testing

This equipment is compliant with the European Directive 2002/95/EC and its latest amendments on Restrictions on Hazardous Substances (RoHS) and below the given limits of hazardous substances.

ETL Intertek (60 Hz units)

UL 61010-1 / CSA C22.2 No. 61010-1 — Safety Requirements for Measurement, Control, and Laboratory Use; Part 1: General Requirements

UL 61010A-2-010 / CSA C22.2 No. 61010-2-010:04 — Safety Requirements for Measurement, Control, and Laboratory Use; Part 2-010: Particular Requirements for Laboratory Equipment for the Heating of Materials

UL 61010A-2-051 / CSA C22.2 No. 61010-2-051:04 — Safety Requirements for Measurement, Control, and Laboratory Use; Part 2-051: Particular Requirements for Laboratory Equipment for the Mixing and Stirring

CE (all units)

EC Low Voltage Directive 2006/95/EC

EC Electromagnetic Compatibility Directive 2004/108/EC

IEC 61010-1-2001

IEC 61010-2-2001

IEC 61326:2005 / EN 61326 : 2006

Unpacking Your Circulator

Your Circulator was packed in a special carton or cartons. You should keep the packaging, along with all packing materials, until the unit has been installed and you are certain it is working properly.

	CAUTION: Remove any loose packing material that may have fallen into the heater/pump housing during shipping. Before powering up, check that nothing remains around the heater or Circulator pump.
---	---

We recommend that you begin using your Circulator immediately to confirm proper operation, since beyond one week you may be eligible for warranty repair only (rather than replacement). You'll find complete warranty information in the back of this manual.

In the unlikely event that the unit was damaged or does not operate properly, contact the transportation company, file a damage claim, and contact the company where your Circulator was purchased.

Contents

The items included with your Circulator will vary depending on which model Circulating Bath you purchased.

	Heating Only Circulators		Refrigerating / Heating Circulators		
	TC-150SD	TC-250SD	TC-550SD	TC-650SD	TC-950SD
Resource Disk (with Operator's Manual)	PS110-817				
Fitting Kit for External Applications **	PS 510-735 (115V) PS 510-736 (230V)				
Bypass Tubing with Spring and Insulation	PS 510-711				
Latex Tubing (6-ft., 0.25" ID)	EX-Tubing (Maximum temperature 80°C)**				
Beaker Platform(s) for Bath Reservoir 600 mL 1000 mL	PS703-038	PS703-038 PS708-039	PS703-038	PS703-038	
Deck Lid(s)	PS510-781	PS510-781 PS510-782 PS510-783	PS510-784	PS510-784	PS510-811
RS232 Communication Output Cable	RSS-P1				
IEC Power Cord	1				
Certificate of Compliance	1				
Quick-Start Guide	1				

*. Includes two each: 1/4" male NPT x 3/8" barb nylon fitting; 1/4" male NPT x 1/4" barb nylon fitting; 1/4" male NPT x 3/16" barb nylon fitting; tube clamp for 1/4" tubing; and tube clamp for 3/8" tubing. 230V units also include 1/4" male NPT to M16 stainless steel adapter.

** For higher temperatures, use part number ULA-45A

Controls and Components

Standard Digital Controller



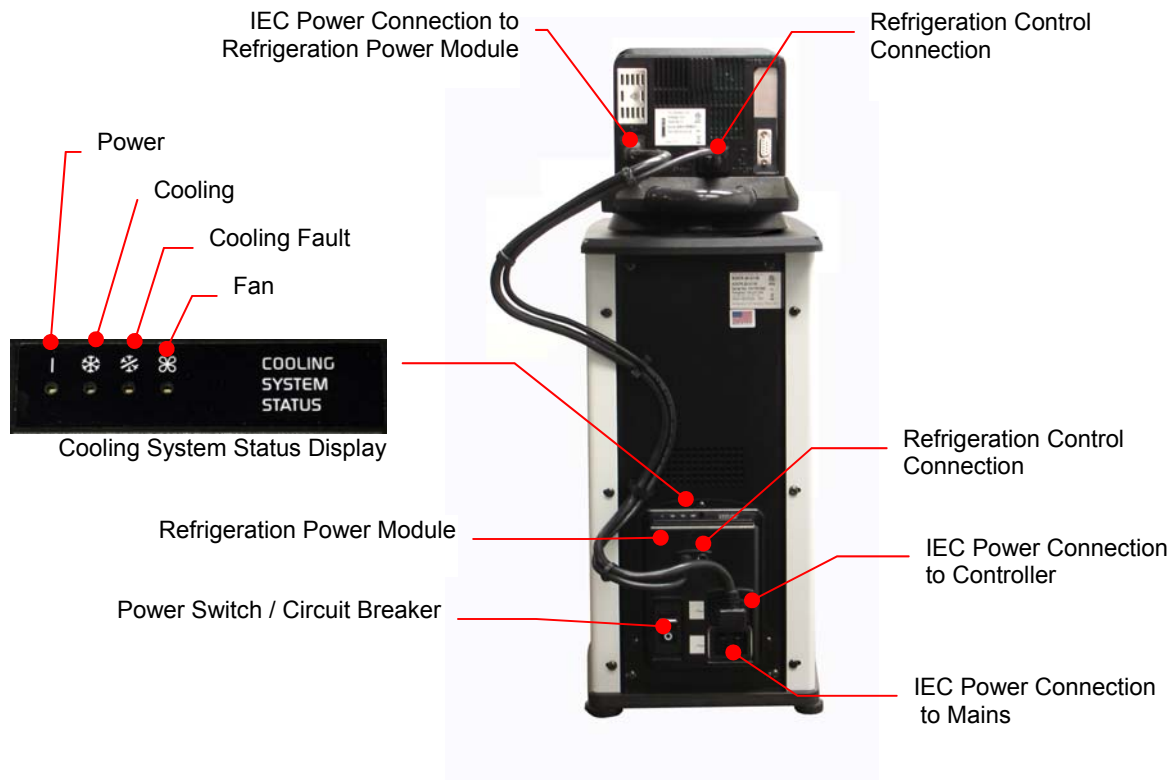
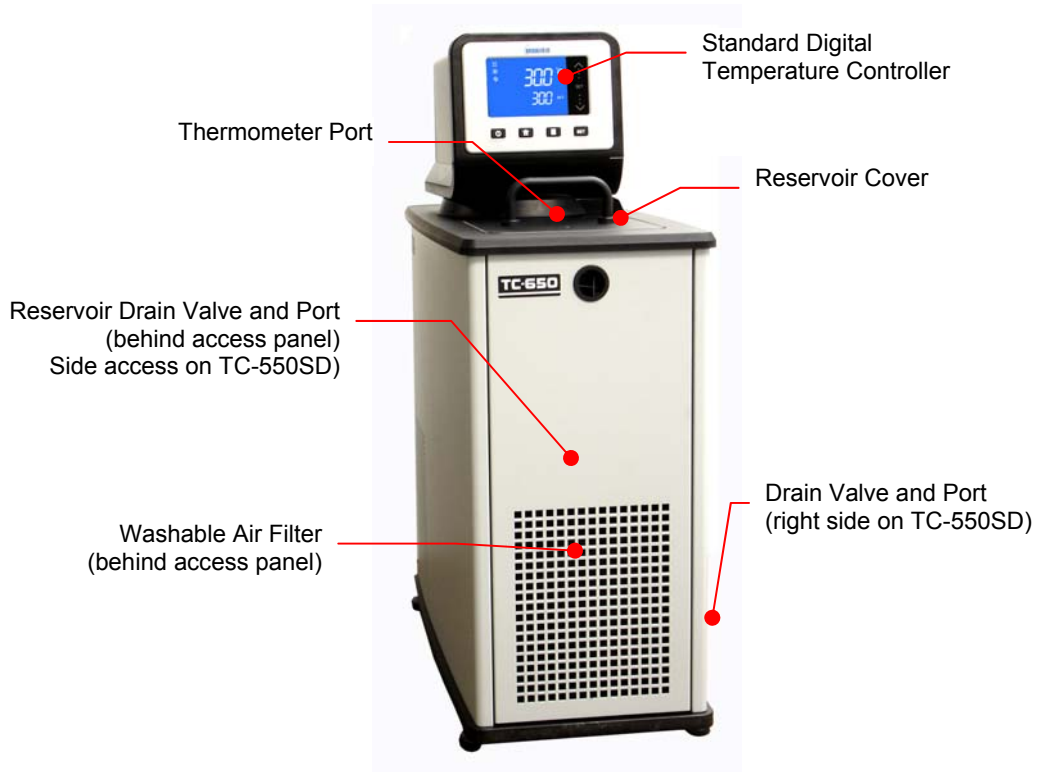

Refrigerating/Heating Baths

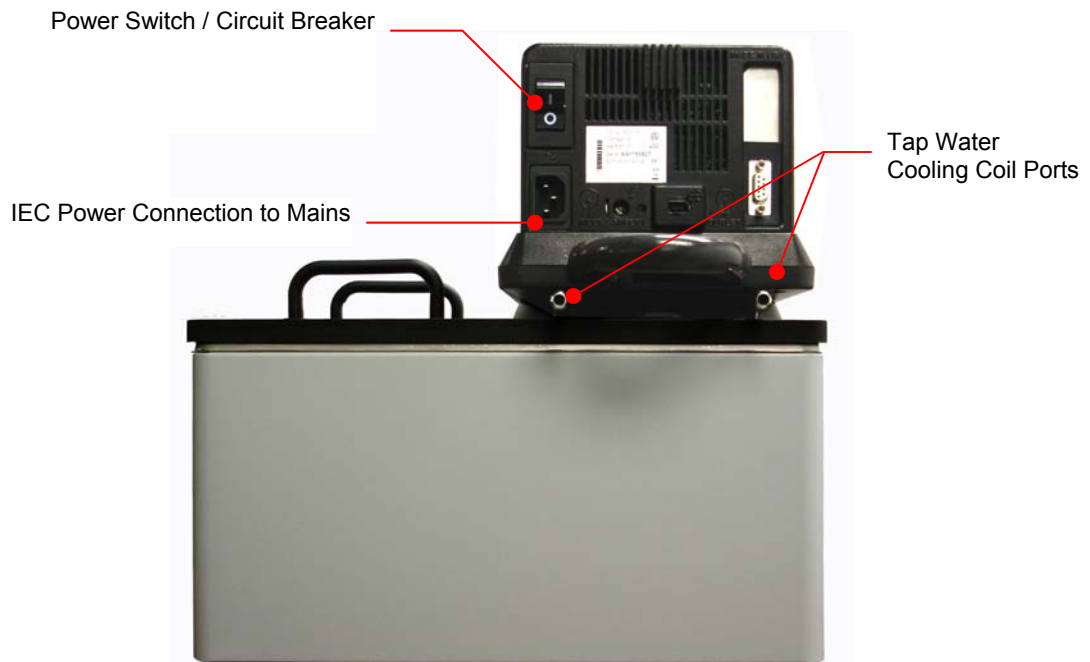

Heating Only Baths



 **WARNING:** Do not lift bath by grasping the Temperature Controller or top deck. Always disconnect electrical power and drain fluid from bath before moving.

 **WARNING:** To avoid the potential for burns, allow the Circulator to cool completely before cleaning or performing any maintenance.

Quick-Start

Unless otherwise specified, quick-start instructions apply to all models.

See Installation and Startup for additional information.

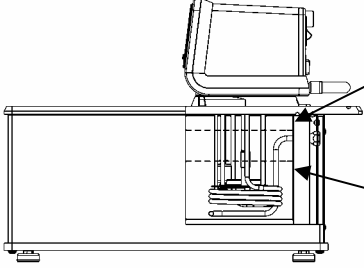
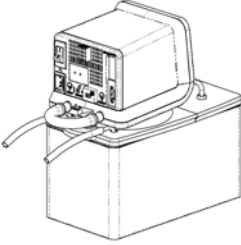
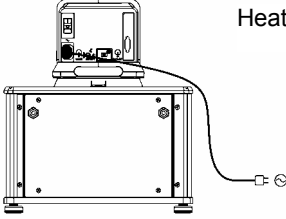
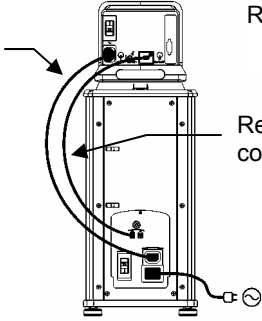
<p>1</p>	<p>Fill reservoir with fluid</p>	 <p>Maximum: 1 in. / 2.54 cm below underside of top deck</p> <p>Minimum: 4.5 in. / 11.5 cm below top deck</p>
<p>2</p>	<p>Models TC-150 and TC-250: Connect cooling coils to external water line (Use of cooling coils is optional)</p>	
<p>3</p>	<p>Connect all electrical power cords and control cables</p>	<div style="display: flex; flex-direction: column;"> <div style="margin-bottom: 20px;">  <p>Heating only models</p> </div> <div>  <p>IEC power cord from Controller to Refrigeration Power Module</p> <p>Refrigerating / heating models</p> <p>Refrigeration control cable</p> </div> </div>

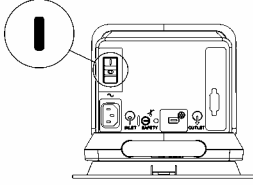
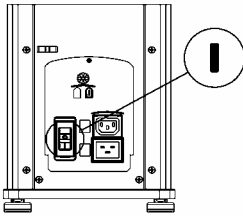
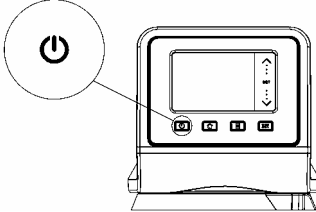
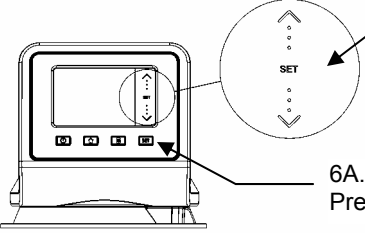
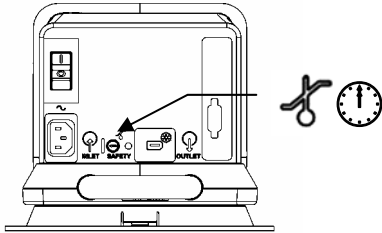
4	Place Power Switch / Circuit Breaker in ON position	 <p>Heating only models</p>
		 <p>Refrigerating / heating models</p>
5	Turn Controller "ON"	
6	Enter temperature set point	 <p>6A. Press SET</p> <p>6B. Touch and hold or slide finger up/down scroll bar</p>
7	Set safety thermostat (See <i>Installation and Startup, Controller Setup, Safety Set Temperature</i> for details)	

Installation and Startup

Your Circulating Bath with Standard Digital Temperature Controller is designed to be simple to set-up and install. The only tools required are a flat-head screwdriver and a container for adding water or other suitable fluid to the bath reservoir.

General Site Requirements

Locate your Circulator on a level surface free from drafts and direct sunlight. Do not place it where there are corrosive fumes, excessive moisture, high room temperatures, or in excessively dusty areas.

Refrigerating / Heating Circulators must be 10.2 cm / 4 inches or more away from walls or vertical surfaces so that airflow is not restricted.

Avoid voltage drops by using properly grounded power outlets wired with 14 gauge or larger diameter wire and if possible, be close to the power distribution panel. The use of extension cords is not recommended; this will reduce the potential for problems caused by low line voltage.

Adding Liquid to the Bath Reservoir

	<p>WARNING: Read the safety data sheet for the bath fluid being used carefully before filling reservoir.</p> <p>WARNING: See Technical Information in the rear of this manual for a list of compatible liquids.</p> <p>WARNING: If the proper fluid level is not maintained, the heater coil may become exposed and possibly damaged (fluid level too low) or the bath may overflow (fluid level too high).</p>
---	--

The liquid in the reservoir should be maintained at a depth between 1 inch / 2.54 cm and 4.5 inches / 11.5 cm below the underside of the bath's top deck. Upon start up, it may be necessary to add fluid to the bath to compensate for the fluid required for external circulation. Likewise, be sure to compensate for fluid displacement when placing samples or other materials in the Circulator's reservoir. See *Technical Information, Reservoir Fluids*.

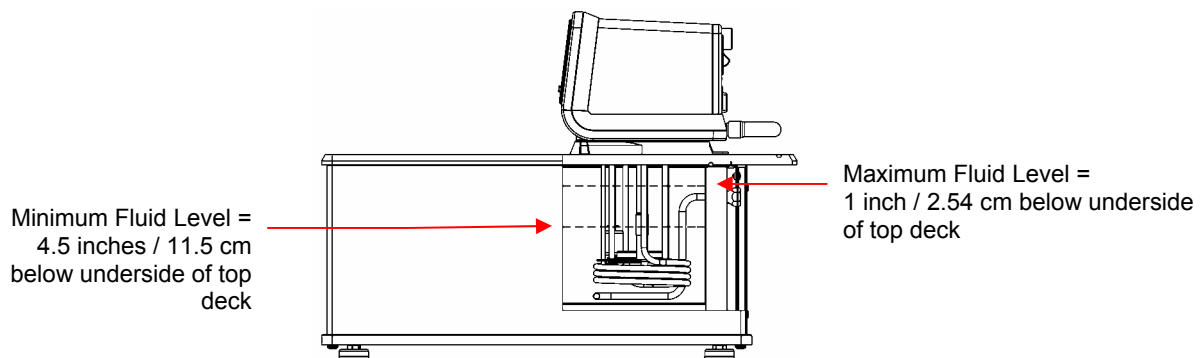

	<p>WARNING: Always drain all fluid from the reservoir before moving or lifting your Circulator. Be sure to follow your organization's procedures and practices regarding the safe lifting and relocation of heavy objects.</p>
---	---

	<p>WARNING: To avoid the potential for burns, allow the Circulator to cool completely before cleaning or performing any maintenance.</p>
---	---

Pump Inlet and Outlet Connections

	<p>WARNING: When connecting tubing to an external application, it is the user's responsibility to make sure that the tubing and fittings connected to the Circulator are suitable for the fluid being used and the temperature range of operation.</p> <p>CAUTION: The Circulator's bypass tubing is secured to the fluid inlet and outlet connections by high temperature nylon hose clamps, which can be removed by carefully cutting them with diagonal cutters.</p> <p>CAUTION: Secure the tubing to the inlet and outlet fittings using hose clamps with a minimum ID of 7/8 inch (22 mm). Do not operate the unit without hose clamps.</p>
---	---

	<p>WARNING: If the Circulating Bath will not be used for external circulation, the inlet and outlet ports should remain connected using the Buna N bypass tubing provided with the unit.</p>
---	---

The pump inlet and outlet ports are female 1/4 inch NPT connections that permit use of barbed tubing adapters or hard plumbing fittings. 1/2 inch (13 mm) ID tubing may also be slid over these connections and held in place with hose clamps (minimum 7/8 inch / 22 mm) ID.

If the pump inlet and outlet are not used for external circulation, the Bypass Tubing provided with the unit should be left in place in order to optimize fluid mixing within the reservoir.

The nylon barbed tubing adapter fittings supplied with the unit are intended for applications from -40° to 93°C. For applications above 93°C, brass, stainless steel, or Teflon® fittings are recommended. 1/4 inch NPT to M16 stainless steel male adapter fittings are provided with all 50Hz models.

	<p>NOTE: The use of quick-connect fittings is not recommended as they typically restrict flow rate.</p>
--	--



External Closed Loop Circulation

Connect the pump inlet and outlet to the external apparatus. To maintain adequate flow, avoid restrictions in the tubing. When connecting the Circulator to more than two closed loops, the use of a manifold made of "Y" adapters to divide the fluid into multiple banks is recommended. After setting up multiple closed loops, check for adequate flow at the return manifold of each loop and check that the bath fluid is at an adequate level. A booster pump may be added to closed loops without damaging the Circulator's pump.

The temperature control stability of a closed loop system is better at the external apparatus than in the Circulator reservoir (provided the control point of the apparatus represents a constant load and is well insulated). For example, if you circulate fluid through a viscometer at 50°C, the temperature variation observed in the Circulator reservoir may be ±0.1°C while the temperature variation in the viscometer may be only ±0.05°C.

Although temperature stability is generally better at the external apparatus control point, depending on the length of tubing used and the efficiency of the insulation, the actual temperature reading at the external apparatus may be slightly different than the temperature reading at the Circulator reservoir.

Refrigeration Control Connections (Refrigerating/Heating Circulators only)

Attach the Refrigeration Control Cable to the Refrigeration Control Connections on the rear of the Temperature Controller and the Refrigeration Power Module.

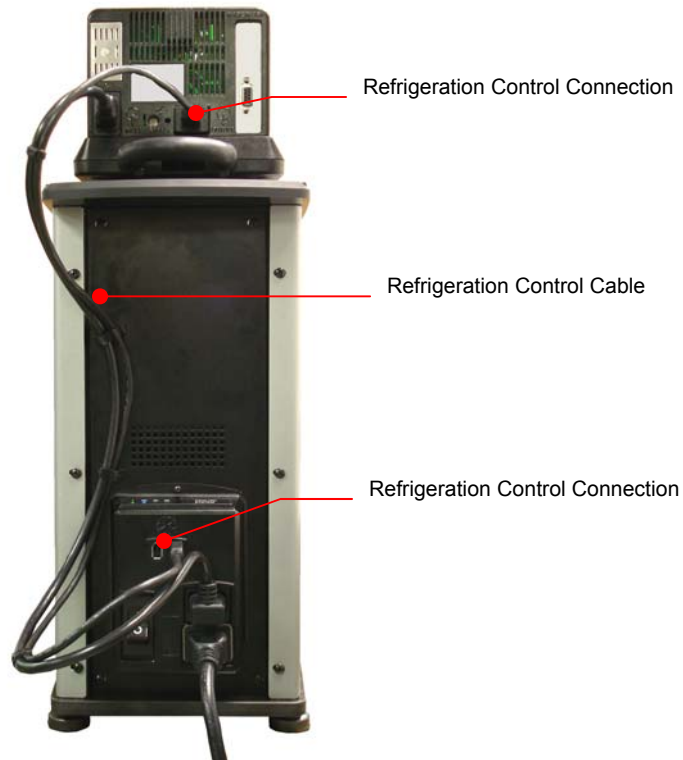

Electrical Power

	WARNING: The Circulator's power cord must be connected to a properly grounded electrical receptacle. Make certain that this electrical outlet is the same voltage and frequency as your Circulator. The correct voltage and frequency for your Circulator are indicated on the identification label on the back of the Controller.
---	---

	CAUTION: The use of an extension cord is not recommended. If one is necessary, it must be properly grounded and capable of handling the total wattage of the unit. The extension cord must not cause more than a 10% drop in voltage to the unit.
---	--

Refrigerating / Heating Circulators

Attach the 3-ft / 0.91 m power cord to the IEC electrical connectors on the Temperature Controller (male) and the Refrigeration Power Module (female).

Attach the 6-ft / 1.8 m power cord to the IEC electrical connection on the Refrigeration Power Module and then plug the male connector into the Mains electrical outlet.

Place the Power Switch / Circuit Breaker on the Refrigeration Power Module in the ON position. The LCD on the Controller will light and "Standby" will appear on the display; the Power Key will also light.



NOTE: To conserve power when not in use, the LCD's backlighting will go out about 5 seconds after "Standby" appears. The Power Key will remain lit to indicate that the Controller is energized and ready to use.

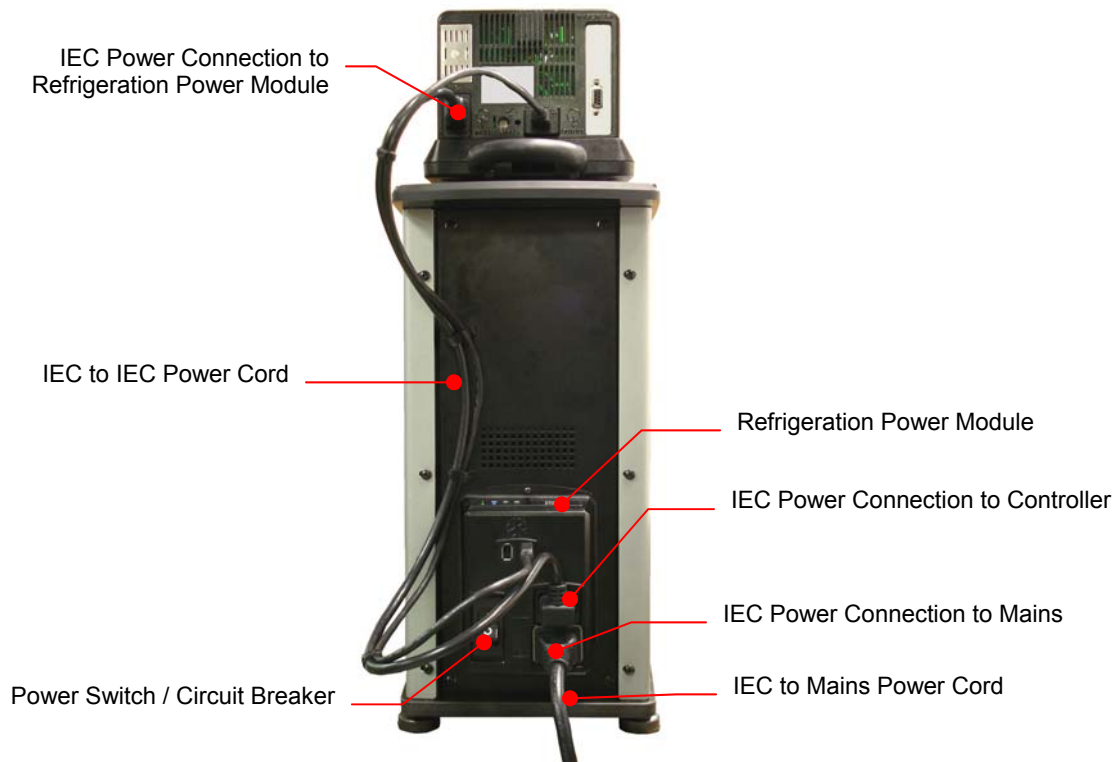

Heat Only Circulators

Attach the 6-ft / 1.8 m power cord to the IEC electrical connection on the Temperature Controller and then plug the male connector into the Mains electrical outlet.

Place the Power Switch / Circuit Breaker on the Temperature Controller in the ON position. The LCD on the Controller will light and "Standby" will appear on the display; the Power Key will also light.



NOTE: To conserve power when not in use, the LCD will go black about 5 seconds after "Standby" appears. The Power Key will remain lit to indicate that the Controller is energized and ready to use.

RS232 Serial Communication



CAUTION: Always turn electrical power to the Circulator OFF before making a connection to the serial (DB9) port.

Your Circulator features RS232 serial communication for remote data logging and control capability. A 9-pin female D-connector is provided on the rear of the Temperature Controller for this purpose.

The serial interface should be connected to a serial communication port on a remote PC using an appropriate cable. Information on the RS232 command and communication protocol can be found in the *Technical Information* section of this manual.

Controller Setup

Power

Press . The Circulator will begin running, actual and set point temperatures will be displayed, and the word "SET" will be continuously lit. The circulating symbol will also be lit and the heating or refrigerating symbol may be lit or flashing.

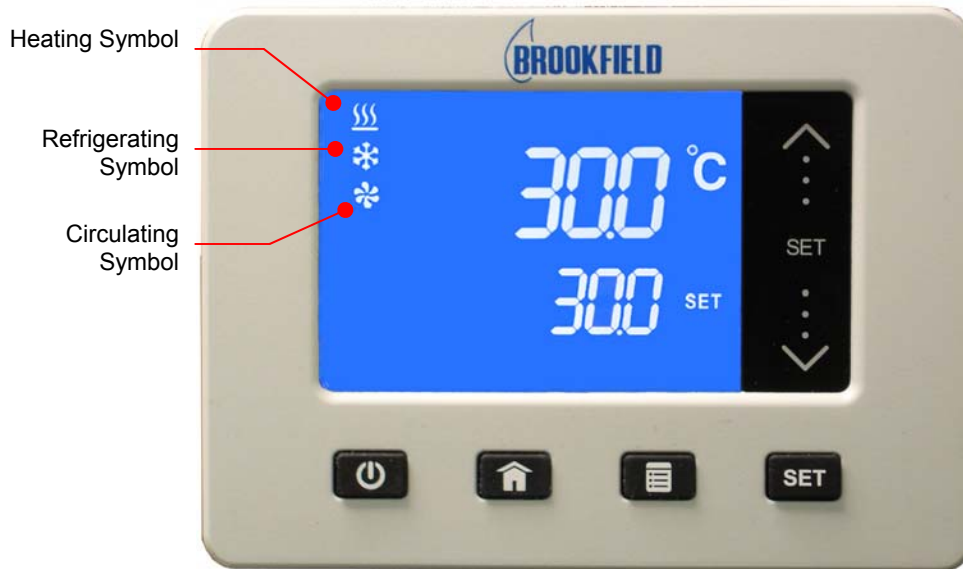

Safety Set Temperature

This is a “Do Not Exceed” temperature setting for your Circulator and is the temperature at which the heater will be turned OFF should the liquid level in the bath drop too low or the heater malfunctions. It is normally set about 5° higher than the desired operating temperature. Setting the Safety Set temperature is a multi-step process.

	WARNING: The Safety Thermostat is user-adjustable from approximately 40° to 210°C. Do not force the indicator dial beyond the stops at either end of the dial's range. The “12:00” o'clock position represents approximately 100°C.
	NOTE: The Safety Set must be manually reset whenever it is tripped. The Reset is located in the vertical slot to the left of the Safety Thermostat.







1. Using a small flat blade screwdriver, rotate the Safety Thermostat clockwise until it stops.
2. Press **SET**. The arrow around the word “SET” and the numerals to the left of the decimal point will begin flashing. Small blue lights will also begin flashing on the touch scroll bar.
3. Place your finger on the touch scroll bar and slide it up / down until the set point temperature is equal to your desired Safety Set temperature. “SET” will stop flashing about 10 seconds after the temperature has been set. Allow the bath to stabilize at this temperature.
4. Once the bath temperature has stabilized, slowly rotate the Safety Thermostat counter-clockwise until the OVERTEMP or LOW FLUID alarm message appears on the display and the alarm sounds. At this point, the heater will also turn OFF.
5. Press **OFF** to turn the Circulator OFF.
6. Allow the bath to cool and then reset the Safety Set by inserting the blade of the screwdriver or the end of a paperclip into the access slot and pressing until you hear the Safety Set reset (an audible click).
7. Press **ON** to turn the Circulator back ON. If the alarm re-activates, repeat steps 5 and 6 until the alarm no longer activates when the Circulator is turned back ON. You are now ready to start normal operation.



Normal Operation

Keys and Controls

Power		Turns the Circulator's Temperature Controller ON.
Home		Returns the LCD to the Main Operational Display (from any screen).
Menu		Accesses the Temperature Controller's set-up sub-menus. The items in these sub-menus are used to configure the Controller's general operational parameters (temperature unit, pump speed, upper and low temperature limits, etc. (See <i>Set-up Sub-Menus</i> section).
SET		Used in conjunction with the Touch Scroll Bar to change the set point temperature.
Touch Scroll Bar		<ul style="list-style-type: none"> Used to make temperature set point and other operational changes. Slide finger up / down scroll bar or touch upper / lower sections to make minor adjustments; press and hold to make large adjustments.

Turning Your Circulator ON

Press the  key.

When the Circulator begins running, the actual and set point temperatures will be displayed and the circulating symbol will be lit.

If the actual bath temperature is lower than the set point temperature, the heating symbol will also be lit.

Refrigerating/Heating Models: If the actual bath temperature is higher than the set point temperature, the refrigerating symbol will be lit. It is normal for both the heating and refrigerating symbols to be lit simultaneously when nearing or maintaining the set point temperature.

Main Operational Display (Home)



This is the Circulators main operational display. You can return to this screen at any time by pressing the  key.



Set-Up Sub-Menus

Pressing the  key accesses the Temperature Controller's set-up sub-menus. The Touch Scroll Bar is used to change the current setting / value in the sub-menus.

Sub-Menu	Selection / Range	Factory Default
Temperature unit	°C or °F	°C
Pump Speed	Low or High	High
Calibration	-3.0°C to +3.0°C	0.0°C
Low Limit	-52° to 20°C / -65° to +65°F	-52°C
High Limit	+25° to +175°C / +80° to +350°F	175°C
Baud	1200, 2400, 4800, 9600, 19200, 38400, 57600	9600
Refrigeration Control (Refrigerating / Heating Circulators only)	1 to 150°C / 34° to 302°F	45°C

To accept a value in a sub-menu, press , , , or allow the LCD to return to the main operational display (approximately 10 seconds).

Adjusting the Temperature Set Point

This is the temperature at which the fluid in your Circulating Bath will be maintained. It may be set to one-tenth of a degree over a range of -50.0° to $+170.0^{\circ}\text{C}$ / -58.0° to $+338^{\circ}\text{F}$. The factory default set point is $+20.0^{\circ}\text{C}$ / $+68.0^{\circ}\text{C}$.



Touch and hold up/down arrows to make large changes

Touch and release arrows or slide finger up /down scroll bar to make small changes

Press once to change whole degree values

Press twice to make changes of less than a degree (decimal point will flash)

To Change: Press **SET**. The arrow around the word "SET" will begin flashing. To make changes of one degree or more, touch the up/down arrows until the desired set point temperature is displayed. To make changes of less than a degree, (e.g., 0.50°C), press **SET** a second time. The decimal point will begin flashing. Touch the up/down arrows until the desired value is displayed.

To Accept: Press **Menu**, **Home**, **SET**, or allow the LCD to return to the main operational display (approximately 10 seconds).



NOTE: An audible alarm and the words Low Limit or High Limit flashing on the display indicate that the temperature set point value is outside the Low Limit or High Limit value. The Circulator will continue to heat/cool until the actual bath temperature reaches the Limit value, at which point operation will stop.

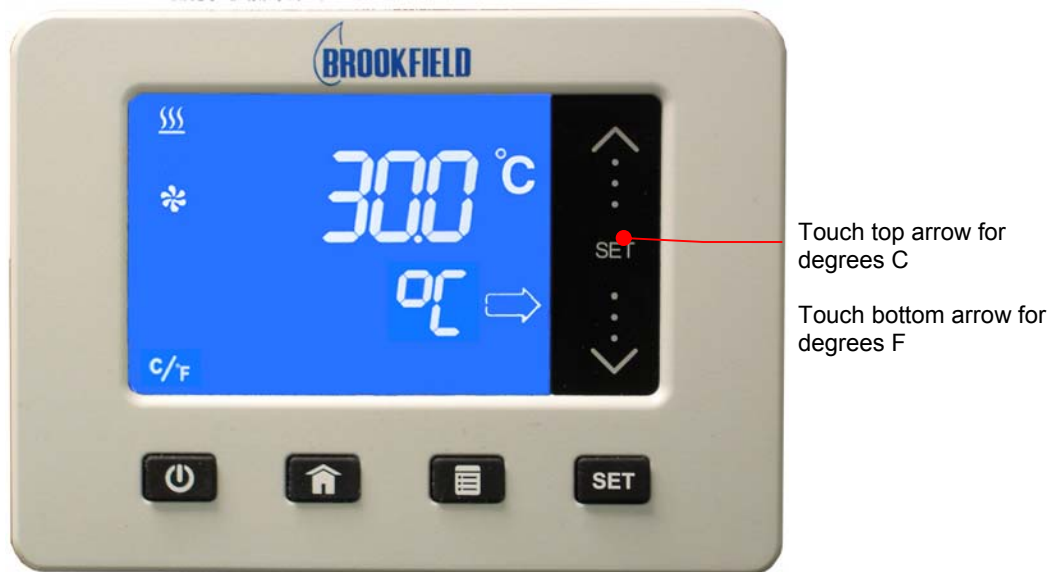

Selecting the Temperature Unit

The temperature units sub-menu ($^{\circ}\text{C}$ / $^{\circ}\text{F}$) allows you to select the temperature unit in which the actual bath temperature and set point temperature are displayed. The factory default is $^{\circ}\text{C}$.



To Access: Press the  key until $^{\circ}\text{C}/^{\circ}\text{F}$ appears on the display.

To Change: To select $^{\circ}\text{F}$, touch the bottom portion of the scroll bar; to select $^{\circ}\text{C}$, touch the top portion of the scroll bar.

To Accept: Press , , , or allow the LCD to return to the main operational display (approximately 10 seconds).



Selecting the Pump Speed

This sub-menu allows you to select your Circulator's pump speed. The choices are Low (LO) and High (HI); the factory default is High (HI).







To Access: Press the  key until PUMP appears on the display.

To Change: To select the high pump speed, touch the top arrow; to select the low pump speed, touch the bottom arrow.

To Accept: Press , , , or allow the LCD to return to the main operational display (approximately 10 seconds).

Calibrating Your Circulator

This sub-menu allows you to match the Circulator's temperature display to an external reference thermometer. A value from -3.0° to +3.0°C may be entered; the factory default is 0.0°C.

	<p>IMPORTANT: To prevent Offset Calibration value from being changed unintentionally, the following power down/power up sequence is required to enable the Calibration function.</p> <ol style="list-style-type: none">1. Place the power switch/circuit breaker on the rear of the unit in the OFF position.2. Return the power switch/circuit breaker to the ON position while pressing and holding the  key.3. When STANDBY appears on the display, release the  key and press . You can now proceed as outlined below. <p>The Calibration function will remain enabled until the electrical power is turned OFF by pressing the  key.</p>
--	---





Touch top arrow to increase calibration offset

Touch bottom arrow to decrease calibration offset

To Access: Press the  key until CALIBRATE appears on the display.

To Change: Touch the arrows until the desired calibration temperature is displayed.

To Accept: Press , , , or allow the LCD to return to the main operational display (approximately 10 seconds).

	<p>CAUTION: The Offset Calibration value is always shown in degrees C, even if degrees F is selected as the temperature unit in which the control and actual bath temperatures are displayed. Your Circulator will automatically convert the °C offset calibration value to the correct °F display offset value.</p>
--	---

Setting the Low Limit Temperature

This sub-menu allows you to limit how low the temperature set point may be set. It also serves as a low limit safety, alerting you if bath temperature falls below the low limit temperature setting. The Low Limit value may be set from -52° to $+20^{\circ}\text{C}$ / -65° to $+68^{\circ}\text{F}$; the factory default is -52°C .

To avoid any unwanted alarms or shutdown during regular operation, the Low Limit value should be set at least 5° lower than the selected control temperature.





Touch and hold the up/down arrows to make large changes

Touch and release to make minor changes

To Access: Press the  key until LOW LIMIT appears on the display.

To Change: Touch the arrows until the desired low limit temperature is displayed.

To Accept: Press , , , or allow the LCD to return to the main operational display (approximately 10 seconds).

Setting the High Limit Temperature

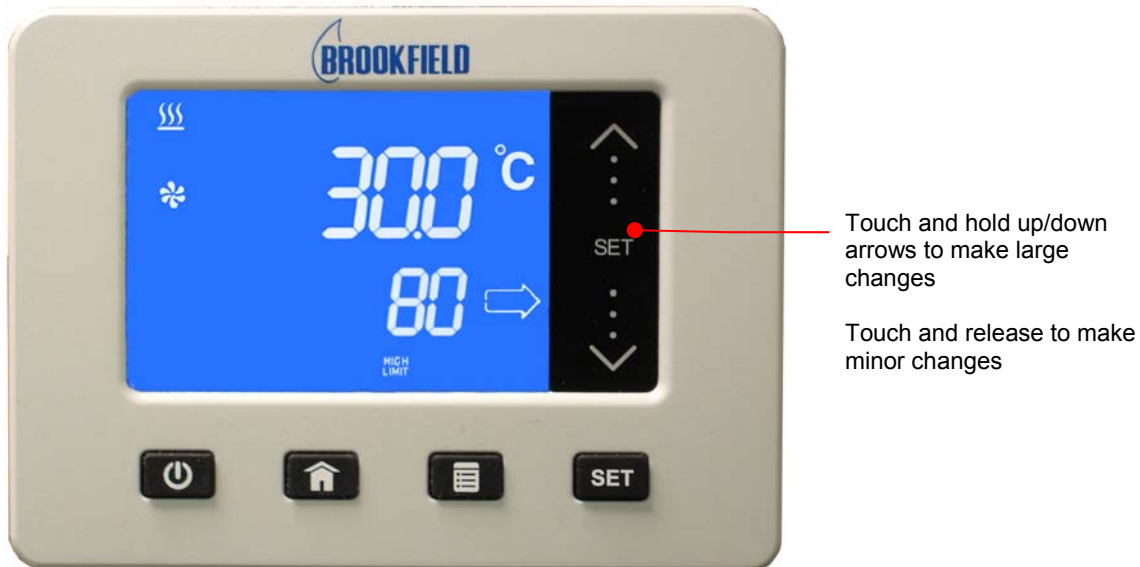

This sub-menu allows you to limit how high the temperature set point may be set. It also serves as a high limit safety, alerting you if bath temperature rises above the high limit temperature setting. The High Limit value may be set from +25° to +175°C / +80° to +350°F; the factory default is 175°C.

To avoid any unwanted alarms or shutdowns during regular operation, the High Limit value should be set at least 5° higher than the selected control temperature.



To Access: Press the  key until HIGH LIMIT appears on the display.

To Change: Touch the arrows until the desired high limit temperature is displayed.

To Accept: Press , , , or allow the LCD to return to the main operational display (approximately 10 seconds).



Selecting the Serial Communication Baud Rate

This sub-menu allows you to select the speed at which your Circulator will transmit data. The setting on both the Circulator and the device it is connected to should match. The baud rate setting may be 1200, 2400, 4800, 9600, 19200; 38400, or 57600; the factory default is 9600.



To Access: Press the  key until BAUD appears on the display.

To Change: To select the 1200 baud rate setting, touch the bottom of the scroll bar; to select the 57600 setting, touch the top of the scroll bar. Rates between these two extremes are selected by touching the corresponding area of the scroll bar (e.g. 9600 baud is at the mid-point of the scroll bar).

To Accept: Press , , , or allow the LCD to return to the main operational display (approximately 10 seconds).



NOTE: When using RS232 communication, the Circulator's baud rate must match that of the connected device.

Setting the Auto Cool Temperature

This sub-menu is displayed only on Refrigerating / Heating Circulators. It determines the bath temperature at which refrigeration will be activated and permits more precise control when operating at high temperatures as well as more rapid cool downs. For most applications, an Auto Cool set point 15°C above room temperature is recommended. The Auto Cool range is from 1° to 150°C. The factory default is 45°C.



Cool Command™ Refrigeration — The TC-950SD Refrigerating/Heating Circulator features the Cool Command™ modulating refrigeration control system. Cool Command allows the refrigeration system to turn on at a fluid temperature up to 150°C when the temperature set point is changed to or below the Auto-Cool set point (150°C maximum). As a result, bath fluid cools more quickly.

Conventional Refrigeration — TC-550SD and TC-650SD Refrigerating/Heating Circulators use a conventional refrigeration system. The refrigeration system will turn on when the bath fluid temperature and set point are below the Auto-Cool set point (70°C maximum).





To Access: Press the  until AUTOCOOL is displayed.

To Change: Touch the arrows until the desired auto cool temperature is displayed.

To Accept: Press , , , or allow the LCD to return to the main operational display (approximately 10 seconds).

Resetting the Factory Default Values

To reset your Circulator to its original factory default values, proceed as follows:

1. Press the  key to place the unit in Standby.
2. Place the Power Switch / Circuit Breaker in the OFF position.
3. Return the Power Switch / Circuit Breaker to the ON position while pressing the  key until "STANDBY" appears on the display.
4. Press the  key.

Changing Your Circulator's Viewing Angle

Your Circulator is equipped with Swivel 180™, an innovative feature which permits viewing of the temperature display from anywhere over a 180° arc.



NOTE: There are positive stops at 45° intervals; however, the viewing angle may be set anywhere within a 180° arc.

To change the viewing angle, slide the release latch to the right and rotate the Temperature Controller to the desired angle. The latch release will automatically return to the locked position at every 45° positive stop.

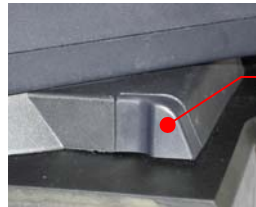

Swivel 180™ Latch Release

Loss of Power Restart



WARNING: The unit will start automatically after a disruption in electrical power.

In the event that electrical power is lost while your Circulator is in use, it will begin operating automatically once power is restored. FAIL POWER will appear on the display to alert you that there was a power disruption. To clear the message, turn the Circulator OFF and then back ON again using the  key.



FAIL POWER
Alerts you to a temporary loss of electrical power









NOTE: The FAIL POWER message will also appear if the Circulator is turned OFF and then back ON using only the Power Switch / Circuit Breaker on the rear of the unit.

Inert Gas Purge

A 0.125 in. / 3 mm port on the rear of the Temperature Controller is provided to allow you to blanket the surface of the liquid in the bath reservoir with nitrogen or another inert gas to help prevent condensation and dilution of the bath fluid.

Display Messages and Alarms

Message and/or Symbol	Description	Corrective Action
FAIL POWER	Informational Message: Indicates that electrical power was lost during operation or that the Circulator was turned OFF using only the power switch/circuit breaker on the rear of the unit.	Using the  key, turn the Circulator OFF and then back ON. This will clear the message.
LOW LIMIT (flashing)	Warning: The temperature set point is below the Low Limit temperature value.	Decrease the Low Limit temperature value or increase the temperature set point.
HIGH LIMIT (flashing)	Warning: The temperature set point is above the High Limit temperature value.	Increase the High Limit temperature value or decrease the set point temperature.
 LOW LIMIT	Alarm: The bath temperature has fallen below the Low Limit temperature value. Power to the compressor and pump will remain OFF until the problem is corrected.	Allow bath to warm or add heat load. Decrease the Low Limit temperature value.
 HIGH LIMIT	Alarm: The bath temperature has risen above the High Limit temperature value. Power to the heater and pump will remain OFF until the problem is corrected.	Allow bath to cool or increase High Limit temperature value.
  OVERTEMP OR  LOW FLUID	Alarm: The liquid in the bath has dropped too low or the temperature of the bath fluid has exceeded the Safety Set temperature. Power to the heater will remain OFF until the problem is corrected.	Fluid level in reservoir has fallen below minimum level; add fluid as required. Fluid temperature is higher than Safety Set temperature; increase Safety Set temperature setting. Controller failure; consult factory.
INTERNAL PROBE FAIL	Fault: The Circulator's temperature sensor has failed.	Consult factory.
HEATER FAIL	Fault: The Circulator's heater has failed.	Consult factory.

Routine Maintenance and Troubleshooting



WARNING: Always turn your Circulator OFF and disconnect it from the electrical power outlet before performing any maintenance or service.



WARNING: To avoid the potential for burns, allow the Circulator to cool completely before cleaning or performing any maintenance.



WARNING: Always drain all fluid from the reservoir before moving or lifting your Circulator. Be sure to follow your organization's procedures and practices regarding the safe lifting and relocation of heavy objects.

Maintaining Clear Bath Water

Optimum temperature and moisture conditions for algae growth existing when using water as a bath fluid. To prevent algae contamination and minimize the frequency of draining the reservoir, an algacide such as TC-Fluid 1A should be used.



WARNING: Do not use chlorine bleach.

Draining the Bath Reservoir



WARNING: Bath fluids should be stored and disposed of according to applicable laws and regulations.

Refrigerating/Heating Circulating Baths with the Standard Digital Temperature Controller are equipped with a drain valve and port located either beneath the front access panel or on the right hand side of the unit.

To drain fluid from the bath, attach a short length of suitable 11.5 mm ID / 0.45 inch ID tubing to the drain port and secure it using a hose clamp with a minimum ID of 18 mm / 0.7 inch. Open the drain valve using a flat blade screwdriver. When closing the valve, do not over tighten.



WARNING: Be sure to close the drain valve before refilling the bath reservoir. Do not over tighten.

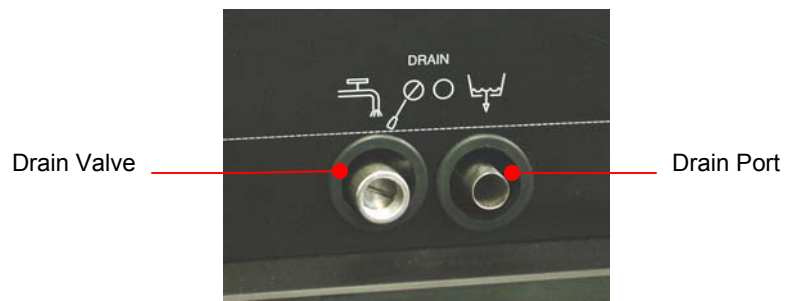

Checking the Over-Temperature Safety System

Your Circulator incorporates over-temperature protection according to IEC 61010. For optimum safety, this system should be checked for proper operation at least every six months. This check must be performed with the unit running.

1. Press **SET**, enter a temperature set point of approximately 50°C, and then allow the bath to stabilize at that temperature. The amount of time this will take will depend on the size of the bath and the difference between the initial bath temperature and the Safety Set temperature.
2. Using a small flat blade head screwdriver, slowly rotate the Safety Thermostat located on the rear of the Temperature Controller counter-clockwise until you hear a soft click; the OVERTEMP or LOW FLUID alarm message will appear and the alarm will sound. The heater should also turn OFF.

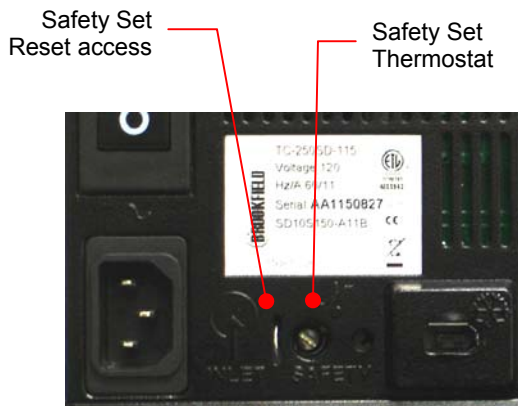

3. Press **⏻** to turn the Circulator OFF.
4. Rotate the Safety Thermostat clockwise a few degrees and then reset the Safety Set by inserting the blade of the screwdriver or the end of a paperclip into the access slot and pressing until you hear the Safety Set reset (an audible click).
5. Press **⏻** to turn the Circulator back ON and reset the Safety Set temperature to the desired temperature value (see *Controller Setup, Safety Set Temperature*).

Cleaning Your Circulator



WARNING: It is the user's responsibility to properly decontaminate the unit in the event hazardous materials are spilled on exterior or interior surfaces. Consult the manufacturer if there is any doubt regarding the compatibility of decontamination or cleaning agents.

Temperature Controller

Turn the Temperature Controller OFF by pressing  and unplug power cord from the electrical outlet.

Wipe the housing with a clean cloth dampened with a mild detergent and water or mild all-purpose cleaner.



CAUTION: Do not spray cleaning liquids directly onto the Temperature Controller or allow them to enter the Controller's vents. Do not use abrasives as these could scratch the housing or the digital display.

Bath Reservoir

Bath Reservoir and Wetted Components — A concentrated bath cleaner (TC-Fluid 6A) is available to remove mineral deposits from the stainless steel reservoir and the Temperature Controller's wetted parts. The cleaner should be added to the bath reservoir at the prescribed dosage and circulated at 60°C / 140°F until the scale is removed.



CAUTION: Do not use steel wool to clean your Circulator's bath reservoir.

External Surfaces — Only mild detergents and water or an approved cleaner should be used on the top deck and other external surfaces of your Circulator. Do not allow cleaning liquids or sprays to enter the vents on the rear of the Temperature Controller.

Pump Impeller

In the unlikely event that debris becomes lodged in the pump impeller, a soft brush can be used to remove any lodged particles. If necessary, soak in a solution of distilled water and bath cleaner (TC-Fluid 6A) to soften before brushing.



CAUTION: Do not use hard utensils or abrasive pads to remove trapped debris.

Condenser, Air Vents, and Reusable Filter (Refrigerating / Heating Circulators only)

To keep the refrigeration system operating at optimum cooling capacity, the condenser, removable air filter, and all air vents (front, side, back) should be kept free of dust and dirt. Be sure to check them on a regular basis and clean as required.

The reusable filter is easily accessed from the front of the unit by simply removing the access panel. Use a mild detergent and water solution to wash off any accumulated dust and dirt. Rinse and dry thoroughly before reinstalling.

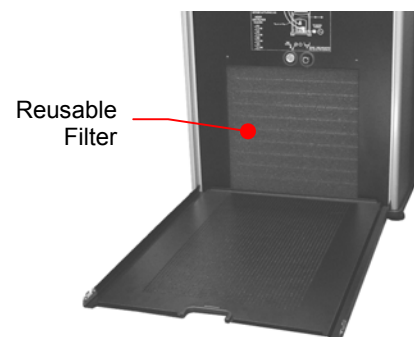

Temperature Controller Removal and Re-Installation

Removal

The Temperature Controller on your Circulating Bath is designed to be easily removed from the top deck without the use of special tools. It is removed as follows:

1. Place the tip of a small flat blade screwdriver under the retaining ring locking tab and pry up gently.

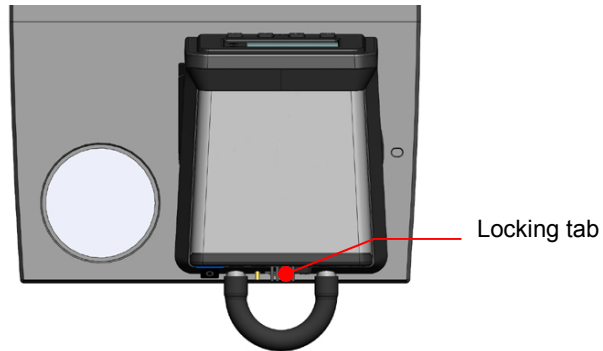

2. Rotate the Temperature Controller clockwise until it stops (about 0.75 inch / 1.9 cm).

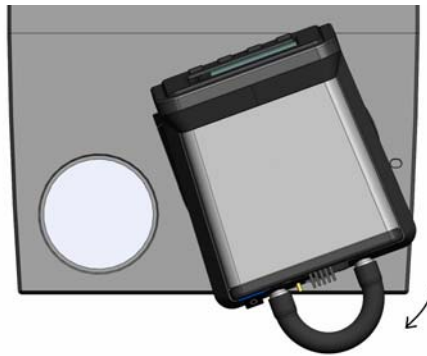

3. Lift the Controller straight up and out of the opening of the Circulator's top deck.

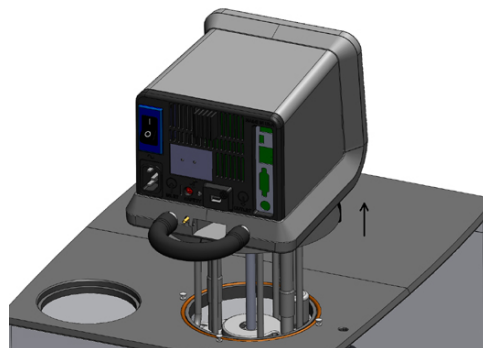

Re-Installation

The top deck of your Circulator incorporates four pins to facilitate positioning of the Temperature Controller when it is being reinstalled. These pins correspond to keyhole slots on the interior of the Circulator's retaining ring.

1. With the retaining ring locking tab oriented above one of the indents on the top deck, slowly lower the Temperature Controller into the top deck opening until it is resting on top of the positioning pins.

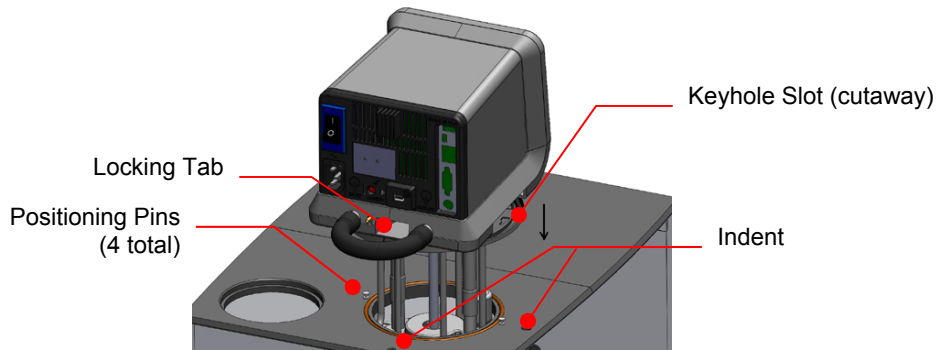

2. Gently rotate the Temperature Controller until it drops down on the positioning pins.

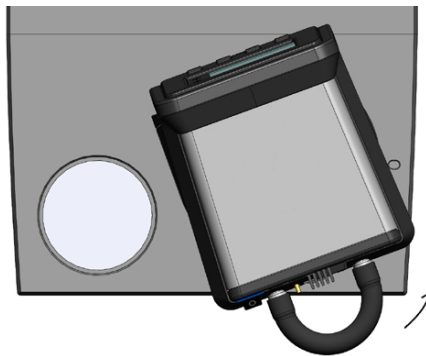

3. Rotate the Temperature Controller counterclockwise until the Locking Tab engages the indent on the top deck.

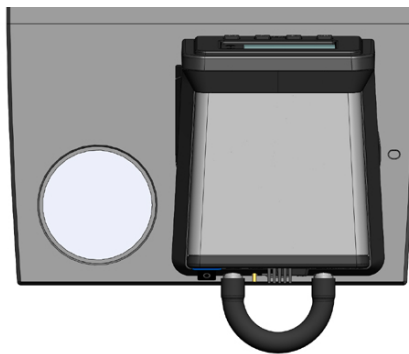

Troubleshooting Chart

Problem	Possible Causes	Corrective Action
Unit does not run (Digital Display is blank)	No power to unit	Check that the electrical cord is secure and connected to an operating electrical outlet.
Unit does not run (STANDBY appears on Digital Display)	Unit in Standby mode	Press Power Key on front panel.
No fluid circulation	Insufficient fluid in reservoir Pump impeller jammed	Add fluid to reservoir. Inspect pump and remove debris as required.
Insufficient circulation	Fluid viscosity too high External tubing diameter too small Low line voltage	Replace with lower viscosity bath fluid. Replace with larger diameter tubing. Check and correct as required.
Unit does not heat	Insufficient fluid in reservoir Temperature set point too low Safety Set Temperature too low	Add fluid to reservoir. Increase temperature set point. Increase Safety Set temperature.
Insufficient heating	Insufficient circulation Low line voltage Ambient temperature too cool Excessive heat loss	See Insufficient Circulation, above. Check and correct as required. Increase ambient temperature or relocate unit. Check for heat loss from external tanks and hoses; Check for vapor/heat loss from internal reservoir.
Temperature unstable	Insufficient circulation Debris or mineral build-up on pump, heater, or temperature sensor.	Check pump flow and operation. Clean as required.
Unit does not cool	Dust build up on air filter or condenser Blocked air ventilation screens Temperature set point is too high Excessive heat load Ambient air temperature too high (>35°C / 95°F) Low or high line voltage	Clean air filter and/or condenser as required. Remove blockages as required. Decrease temperature set point. Check that heat load does not exceed capacity of bath; correct as required. Decrease ambient air temperature. Check and correct as required.

Problem	Possible Causes	Corrective Action
Insufficient cooling	Dust build up on air filter or condenser Blocked air ventilation screens Temperature set point is too high Excessive heat load Ambient air temperature too high (>35°C / 95°F) Low or high line voltage	Clean air filter and/or condenser as required. Remove blockages as required. Decrease temperature set point. Check that heat load does not exceed capacity of bath; correct as required. Decrease ambient air temperature. Check and correct as required.
Unable to achieve low end extreme temperatures	Pump speed too high Incorrect bath fluid Insufficient insulation on external fluid lines Ambient air temperature too high (>35°C / 95°F) Low or high line voltage Dust build up on air filter or condenser Blocked air ventilation screens Excessive heat load	Reduce pump speed. Check that the fluid being circulated is capable of reaching the required temperature. Check external fluid lines for proper insulation. Decrease ambient air temperature as required. Check and correct as required. Clean air filter or condenser as required. Remove blockages as required. Check that heat load does not exceed capacity of bath; correct as required.

Technical Information

Reservoir Fluids

Depending on your needs, a variety of fluids can be used with your Circulator. No matter what bath fluid is selected, it must be chemically compatible with the reservoir and the materials in your Circulator. It must also be suitable for the desired temperature range.

	WARNING: Do not use a flammable liquid as a bath fluid as a fire hazard may result.
---	--

	WARNING: Always use fluids that satisfy safety, health, and equipment compatibility requirements. Be aware of the chemical hazards that may be associated with the bath fluid used. Observe all safety warnings for the fluids used as well as those contained in the material safety data sheet.
---	--

For optimum temperature stability, the fluid's viscosity should be 50 centistokes (cSt) or less at its lowest operating temperature. This permits good fluid circulation and minimizes heating from the pump.

For temperatures from 10°C to 90°C, distilled water is recommended. For temperatures below 10°C, a mixture of laboratory grade ethylene glycol and water should be used. Do not use deionized water.

The following chart is intended to serve as a guide in selecting a bath fluid for your application. For optimum temperature stability and low vaporization, be sure to stay within the fluid's normal temperature range.

You are responsible for proper selection and use of the fluids. Avoid extreme range operation.

Fluid Description	Viscosity (cSt) @ 25°C	Specific Heat			Normal Temperature Range	Extreme Temperature Range
		@ Fluid Temperature	BTU/lb°F	KJ/Kg°C		
distilled water	1	50°C	1.00	4.18	10° to 90°C	2° to 100°C
TC-Fluid 3	50	100°C	0.41	1.71	50° to 150°C	5° to 270°C*
TC-Fluid 4	125	150°C	0.40	1.67	100° to 200°C	80° to 232°C*
TC-Fluid 5	3	-30°C	0.62	2.59	-50° to 100°C	-62° to 118°C
TC-Fluid 2 (when mixed 50/50 with distilled H ₂ O)	20	-20°C	0.78	3.26	-25° to 100°C	-30° to 115°C

	*WARNING: This is the fluid's flash point temperature.
---	---

	<p>WARNING: DO NOT USE THE FOLLOWING LIQUIDS:</p> <ul style="list-style-type: none"> • Automotive antifreeze with additives** • Hard tap water** • Deionized water with a specific resistance > 1 meg ohm • Any flammable fluids • Concentrations of acids or bases • Solutions with halides: chlorides, fluorides, bromides, iodides or sulfur • Bleach (Sodium Hypochlorite) • Solutions with chromates or chromium salts • Glycerine • Syltherm fluids <p>** At temperatures above 40°C, additives or mineral deposits can adhere to the heater. If deposits are allowed to build up, the heater may overheat and fail. Higher temperatures and higher concentrations of additives will hasten deposit build up.</p>
---	---

Application Notes

At a fluid's low temperature extreme:

- The presence of ice or slush adversely affects temperature stability.
- A viscosity above 10 centistokes adversely affects temperature uniformity.
- A high fluid viscosity and high pump speed adds heat to the fluid being pumped.

At a fluid's temperature above ambient without refrigeration:

- If your set point temperature is less than 15°C above the ambient temperature, the viscosity of the fluid should be 10 centistokes or less to minimize friction heating of the fluid.
- Heat loss should be encouraged by uncovering the fluid and lowering the pump speed.

At fluid's high temperature extreme:

- Heat loss from vapor adversely affects temperature stability.
- To prevent the accumulation of vapors inside the room, the reservoir may need to be placed in a fume hood.
- Use a cover and/or floating hollow balls to help prevent heat and vapor loss.
- Replenish fluid lost from vapor frequently.

RS232 Communications



CAUTION: Always turn electrical power to the Circulator OFF before making a connection to the serial (DB9) port.

Serial Connector — A DB9 connector is provided on the back panel of the Controller for RS232 data communication.

Pin	RS232
1	
2	TX
3	RX
4	DTR
5	GND
6	DSR
7	RTS
8	CTS
9	

Using Bath Controller with Rheocalc Software

The controller may communicate with Brookfield Engineering Rheocalc Software (V2.0 or higher). The controller must be connected to the computer with the appropriate RS232 serial cable.

RS232 Protocol — Rheocalc Software uses the following RS232 protocol:

Data bits — 8

Parity — None

Stop bits — 1

Flow control — None

Baud rate — Selectable (Temperature Controller/PC baud rates must match; 9600 is recommended).

Using Bath Controller with DV-III+ or DV-III Ultra Rheometer in Standalone Mode

The bath can also be controlled directly from a DV-III+ or DV-III Ultra Rheometer (version 5.0) without using Rheocalc. Use optional cable (DVP-207) connected from the serial port on the Rheometer base to the RS232 serial port on the bath controller head. Please see additional instructions with your Rheometer Operator Manual if you wish to use this mode.

RS232 — For use without Brookfield Software (for customers using their own software)

Serial Connector — A 9-pin D connector is provided on the back of the Temperature Controller for RS232 data communication. A serial cable that uses only the following pins should be used to connect the Temperature Controller to the computer:

- Pin #2 — Data read (data from computer)
- Pin #3 — Data transmit (data to computer)
- Pin #5 — Signal ground

	IMPORTANT: Do not use a serial cable that connects to the unused pins on the Temperature Controller's RS232 connection.
---	--

RS232 Protocol — The Temperature Controller uses the following RS232 protocol:

- Data bits — 8
- Parity — None
- Stop bits — 1
- Flow control — None
- Baud rate — Selectable (Temperature Controller/PC baud rates must match; 57600 is recommended).

Communication Commands — Commands must be entered in the exact format shown. Do not send a LF (line feed) after the [CR] (carriage return). Be sure to follow character case exactly.

A response must be received from the Temperature Controller before another command can be sent. All responses are terminated with a single [CR], ASCII value = 13.

COMMAND	FORMAT	RESPONSE
Read current fluid temperature	T{CR}	Tttttuz{CR}
Read current set point	S{CR}	Sssssuz{CR}
Change set point *	RSssssu{CR}	RSssssuz{CR}
Read remaining ramp time	M{CR}	Mmmmmz{CR}
Set ramp time *	RMmmmm{CR}	RMmmmmz{CR}
Identifies controller	I{CR}	Ixxxxxx{CR}
Illegal command	All illegal characters{CR}	?{CR}
Set RUN mode **	RAz{CR}	RA1{CR}
Set STANDBY mode **	RAz{CR}	RA2{CR}

*. To change set point or set ramp time, enter the command, wait for the response, and then enter RA1{CR}.

** The Temperature Controller may be forced into only two states using the RA command: **RA1{CR}** (Run) and **RA2{CR}** (Standby).

Legend:

ssss	Set point (multiplied by 10)
ttt	Temperature (multiplied by 10)
mmmm	Ramp time in minutes and tenths of minutes (multiplied by 10)
u	Temperature units digit (F or C)
xxxxxx	Controller ID (TC-501 for all models)
z	Controller status (1 or 2)

Controller Status [z]:

1	Controller ON, in RUN mode
2	Controller OFF, in STANDBY mode
3	No probe connected to controller
5	Temperature reading is above or below allowable limits
6	Temperature input values outside the allowable limits

Equipment Disposal (WEEE Directive)

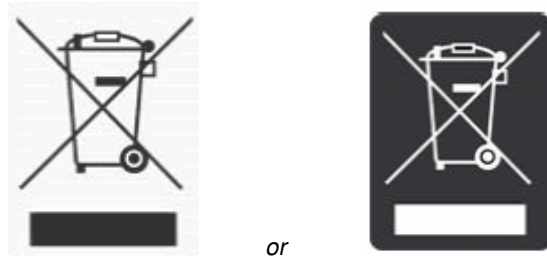

This equipment is marked with the crossed out wheeled bin symbol to indicate it is covered by the Waste Electrical and Electronic Equipment (WEEE) Directive and is not to be disposed of as unsorted municipal waste. **Any products marked with this symbol must be collected separately, according to the regulatory guidelines in your area.**

It is your responsibility to correctly dispose of this equipment at lifecycle-end by handing it over to an authorized facility for separate collection and recycling. It is also your responsibility to decontaminate the equipment in case of biological, chemical and/or radiological contamination, so as to protect the persons involved in the disposal and recycling of the equipment from health hazards. By doing so, you will help to conserve natural and environmental resources and you will ensure that your equipment is recycled in a manner that protects human health.

Requirements for waste collection, reuse, recycling, and recovery programs vary by regulatory authority at your location. Contact your local responsible body (e.g., your laboratory manager) or authorized representative for information regarding applicable disposal regulations.

Replacement Parts. Optional Accessories & Fluids

Replacement Parts, Standard Digital Controller	Part Number BEL
Bypass Tubing Kit. Short hose with internal spring connecting the inlet and outlet ports of the circulator.	PS510-711
Hose Fitting Kit (SD). Includes two threaded pipe to barbed hose adapters.	PS510-735 (115 volt) PS510-736 (230 volt)
Beaker Platform, small. 1.5" height	PS703-038
Beaker Platform, large. 0.75"-1.5" height for use with TC-250 bath	PS703-039
Deck Lid Cover, TC-150. Flat iron opening (5.03" x 4.27")	PS510-781
Deck Lid Covers, TC-250. Split cover male (5.69" x 5.565")	PS510-782
Deck Lid Covers, TC-250. Split cover female (5.94" x 5.565")	PS510-783
Deck Lid Covers, TC-250. Flat iron opening (5.03" x 4.27")	PS510-781
Deck Lid Cover, TC-550 and TC-650	PS510-784
Deck Lid Cover, TC-950	PS510-811
Resource Disk. Includes all literature and manuals.	PS110-817
Reusable Air Filter, TC-550	PS305-057
Reusable Air Filter, TC-650	PS305-054
Reusable Air Filter, TC-950	PS305-055
O-Ring for Drain Valve, TC-550 and TC-650 baths	PS400-934
Accessory connection Hose, rated for -50° to +80°C	EX-Tubing
Refrigeration Control Cable. TC-550, TC-650, and TC-950	PS225-651
RS232 communication output cable	RSS-P1
Optional Accessories	
Ball Valve to control external circulator flow	SB-21
Insulated Tubing, rated for -40° to +120°C	TC-Tubing
High Temperature Fluoran Tubing Kit, rated for -40° to +200°C	ULA-45A
Beaker Cover. Stainless steel split beaker cover with openings for spindle, guard leg, and temperature probe.	PB-1Y
Fluids	
Algaecide, 8 oz.	TC-Fluid 1A
Ethylene Glycol. Laboratory grade, 1 gallon (-20° to +100°C when mixed 50/50 with distilled water)	TC-Fluid 2
High Temperature Fluid (50° to 150°C). 1 gallon	TC-Fluid 3
High Temperature Fluid (100° to 200°C). 1 gallon	TC-Fluid 4
Low Temperature Fluid (-50° to +100°C). 1 gallon	TC-Fluid 5
Bath Cleaner, 8 oz.	TC-Fluid 6A

Warranty Repair and Service

Brookfield TC-Series Circulating Temperature Baths are guaranteed for two years from date of purchase against defects in materials and workmanship. The temperature baths must be returned to **Brookfield Engineering Laboratories, Inc.** or to the Brookfield dealer from whom it was purchased for warranty service. Transportation is at the purchaser's expense.

When returning to Brookfield in the USA, please contact us for a Return Goods authorization number and shipping instructions; failure to do so may result in a longer repair time.

For repair or service in the **United States** contact:

Brookfield Engineering Laboratories, Inc.
11 Commerce Boulevard
Middleboro, MA 02346 U.S.A.
Telephone: (508) 946-6200 FAX: (508) 923-5009
www.brookfieldengineering.com

For repair or service outside the United States, consult Brookfield Engineering Laboratories, Inc. or the dealer from whom you purchased the instrument.

For repair or service in the **United Kingdom**:

Brookfield Viscometers Limited
Brookfield Technical Centre
Stadium Way
Harlow, Essex CM19 5GX, England
Telephone: (44) 1279/451774 FAX: (44) 1279/451775
www.brookfield.co.uk

For repair or service in **Germany**:

Brookfield Engineering Laboratories Vertriebs GmbH
Hauptstrasse 18
D-73547 Lorch, Germany
Telephone: (49) 7172/927100 FAX: (49) 7172/927105
www.brookfield-gmbh.de

For repair or service in **China**:

Guangzhou Brookfield Viscometers and Texture Instruments Service Company Ltd.
Suite 905, South Tower, Xindacheng Plaza
193 Guangzhou Da Dao Bei, Yuexiu District
Guangzhou, 510075 P. R. China
Telephone: (86) 20/3760-0548 FAX: (86) 20/3760-0548
www.brookfield.com.cn

Manufactured by:

PolyScience

6600 W. Touhy Avenue Niles, IL 60714 U.S.A.

1-800-229-7569 • 1-847-647-0611

www.polyscience.com